



ToyotaOwnersOnline.com

CUSTOMER EXPERIENCE CENTER

1-800-331-4331

FJ CRUISER

2 0 1 0

QUICK REFERENCE GUIDE

2010 FJ Cruiser

This *Quick Reference Guide* is a summary of basic vehicle operations. It contains brief descriptions of fundamental operations so you can locate and use the vehicle's main equipment quickly and easily.

The *Quick Reference Guide* is not intended as a substitute for the *Owner's Manual* located in your vehicle's glove box. We strongly encourage you to review the *Owner's Manual* and supplementary manuals so you will have a better understanding of your vehicle's capabilities and limitations.

Your dealership and the entire staff of Toyota Motor Sales, U.S.A., Inc. wish you many years of satisfied driving in your new FJ Cruiser.

! A word about safe vehicle operations

This *Quick Reference Guide* is not a full description of FJ Cruiser operations. Every FJ Cruiser owner should review the *Owner's Manual* that accompanies this vehicle.

Pay special attention to the boxed information highlighted in color throughout the *Owner's Manual*. Each box contains safe operating instructions to help you avoid injury or equipment malfunction.

All information in this *Quick Reference Guide* is current at the time of printing. Toyota reserves the right to make changes at any time without notice.

Tire Pressure Monitoring (warning) System

If tire pressure becomes critically low on any of the tires (including the spare), "(!)" indicator light will come on. Correctly adjusting tire inflation will turn off the light after a few minutes. If the light does not turn off, have the system checked by your Toyota dealer.

Refer to the *Owner's Manual* for more details.

Spare tire & tools

Tool location

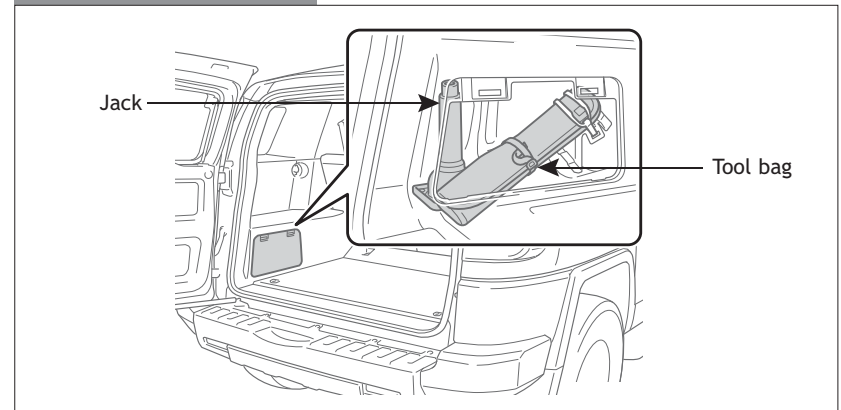

Removing the spare tire

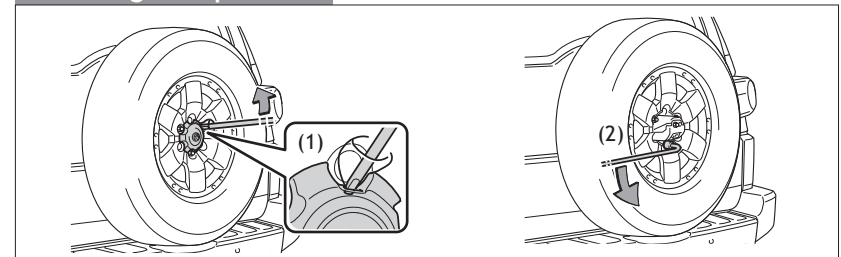

- (1) Remove the wheel ornament (aluminum wheel only).
- (2) Turn the hold-down nuts counterclockwise and remove.

Refer to the *Owner's Manual* for jack positioning and tire changing procedures.

INDEX

OVERVIEW

Engine maintenance	7
Fuel tank door release and cap	6
Hood release	7
Indicator symbols	4-5
Instrument cluster	4
Instrument panel	2-3
Keyless entry¹	6

FEATURES/OPERATIONS

Accessory meter	13
Air Conditioning/Heating	16
Audio	14-15
Automatic Transmission	8
Bottle holders-Rear seat	19
Clock	16
Cruise control	17
Cup holders	19
Door-Back	13
Four-wheel drive	9
Intuitive parking assist	17
Light control-Instrument panel	17
Lights¹ & turn signals	12
Parking brake	10
Power outlet-12V DC	18
Power outlet-115V AC	18
Seat adjustments-Front	10
Seats-Folding rear seats	11
Seats-Head restraints	10
Seats-Removing rear seats	11
Tilt steering wheel	8
VSC OFF button	18
Windows	13
Windshield wipers & washers	12

SAFETY AND EMERGENCY FEATURES

Door locks	20
Seat belts	20
Seat belts-Shoulder belt anchor	20
Spare tire & tools	21
Tire Pressure Monitoring (warning) System	21

¹ Visit your Toyota dealer for information on this and other customizable options.

OVERVIEW

Instrument panel

Steering wheel controls (if equipped)

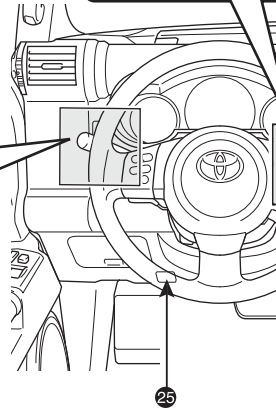
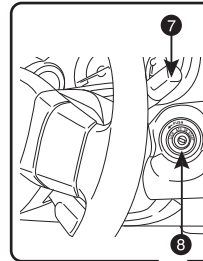
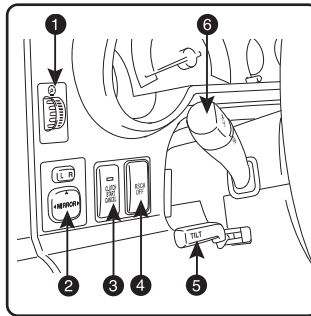
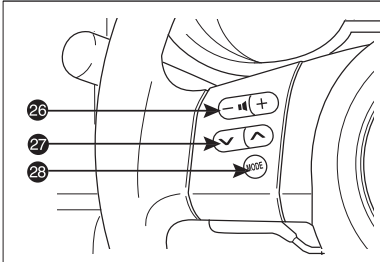

- 1 Instrument panel light control
- 2 Power rearview mirror controls*
- 3 Clutch start cancel switch*
- 4 Roll Sensing of Curtain shield Airbag OFF switch
- 5 Tilt steering lock release
- 6 Headlight and turn signal control
- 7 Wiper and washer controls
- 8 Ignition switch
- 9 Emergency flasher button
- 10 Clock
- 11 Front passenger seat belt reminder light
- 12 Audio system
- 13 Engine immobilizer indicator
- 14 Air Conditioning controls
- 15 Rear window defogger button
- 16 VSC OFF switch*

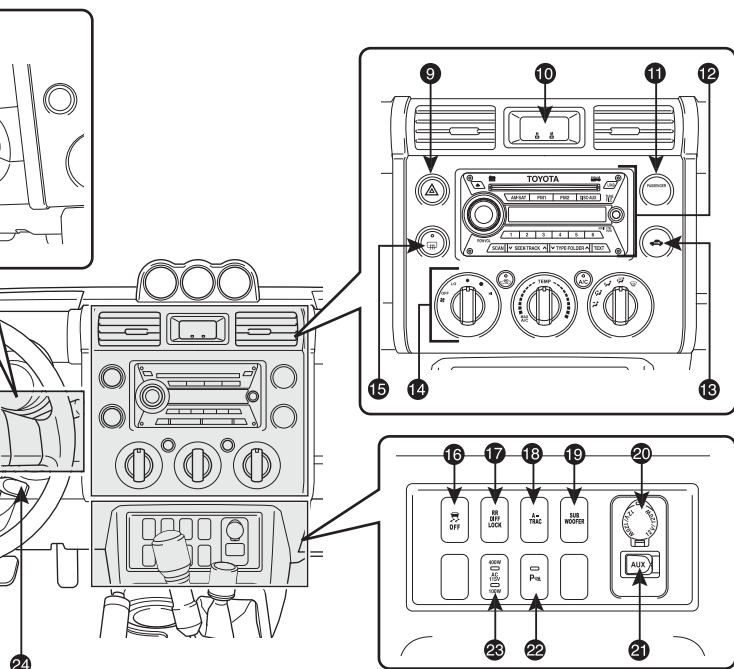

- 17 Rear differential lock button*
- 18 Active traction control switch*
- 19 Sub woofer ON-OFF button*
- 20 Power outlet
- 21 AUX audio jack
- 22 Intuitive parking assist switch*
- 23 Power outlet main switch*
- 24 Cruise control*
- 25 Hood release
- 26 Volume control switch (for audio)*
- 27 "V ▲" button (for audio)*
- 28 "MODE" button (for audio)*

* If equipped

Instrument cluster

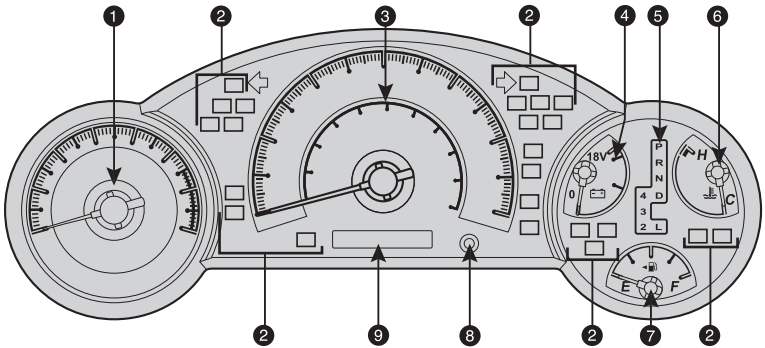





















- ❶ Tachometer
- ❷ Service indicators and reminder
- ❸ Speedometer
- ❹ Voltmeter
- ❺ Automatic Transmission indicator
- ❻ Engine coolant temperature
- ❼ Fuel gauge
- ❽ Trip meter reset knob
- ❾ Odometer and two trip meters

Indicator symbols

	Brake system warning ¹
	Driver/Front passenger seat belt reminder ¹ (alarm will sound if speed is over 12 mph)
	Battery warning ¹
	Low engine oil pressure warning ¹
	Malfunction/Check Engine indicator ¹
	Engine oil replacement reminder ¹
	Low fuel level warning ¹
	Open door warning ¹

¹ For details, refer to "If a warning light turns on or a warning buzzer sounds" Section 5-2, 2010 Owner's Manual.

² For details, see "Rear differential lock system," Section 2-4, 2010 Owner's Manual.

	Airbag SRS warning ¹
	Automatic Transmission fluid temperature warning ¹
	Unengaged Park warning ¹
	Low Tire Pressure Warning ¹
	Engine immobilizer system indicator
	Front passenger occupant classification indicator
	Headlight high beam indicator
	Turn signal indicator
	Automatic Transmission indicator
	Rear differential lock indicator ²
	Center differential lock indicator ³
	Vehicle Stability Control OFF indicator
	Four-wheel drive indicator ³
	Slip indicator ¹
	AUTO Limited Slip Differential indicator
	Active traction control system indicator
	Roll Sensing of Curtain shield Airbag OFF indicator
	Traction Control/OFF indicator
	Cruise control indicator ⁴
	Anti-lock Brake System warning ¹

³ If this light flashes, refer to "Four-wheel drive system," Section 2-4, 2010 Owner's Manual.

⁴ If this light flashes, refer to "Cruise control," Section 2-4, 2010 Owner's Manual.

Fuel tank door release and cap

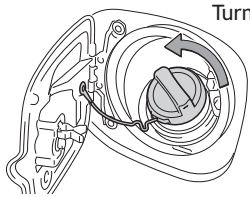
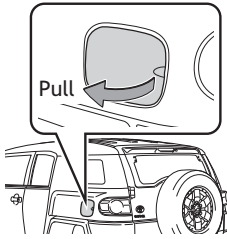

Turn

NOTE: Tighten until one click is heard. If the cap is not tightened enough, Check Engine "CHECK ENGINE" indicator may illuminate.

Keyless entry (if equipped)

Beep sound can be switched ON or OFF. Refer to the *Owner's Manual* for more details.

Locking operation

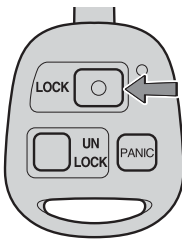

Push



Unlocking operation

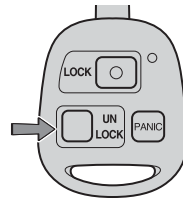

Push ONCE: Driver door
TWICE: All doors



NOTE: If a door is not opened within 60 seconds of unlocking, all doors will relock for safety.

Panic button

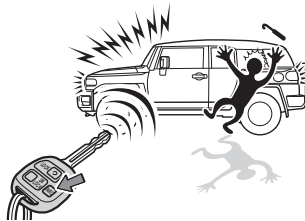

Push and hold



Hood release

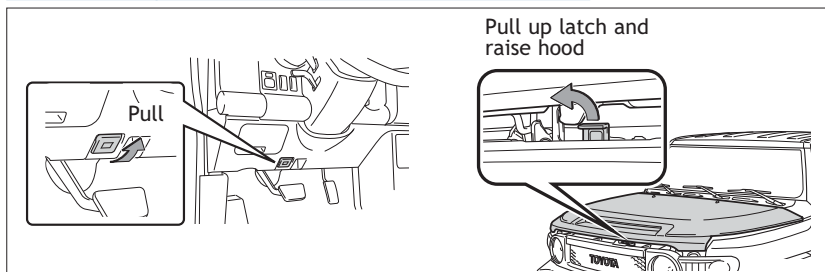

Engine maintenance

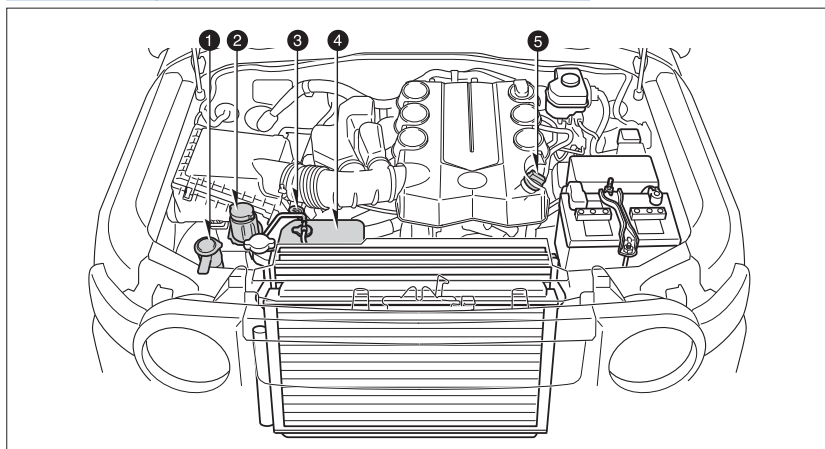

- 1 Windshield washer fluid tank
- 2 Power steering fluid reservoir
- 3 Engine oil level dipstick
- 4 Engine coolant reservoir
- 5 Engine oil filler cap

NOTE: Regularly scheduled maintenance, including oil changes, will help extend the life of your vehicle and maintain performance. Please refer to the "Warranty Maintenance Guide."

FEATURES/OPERATIONS

Automatic Transmission (if equipped)

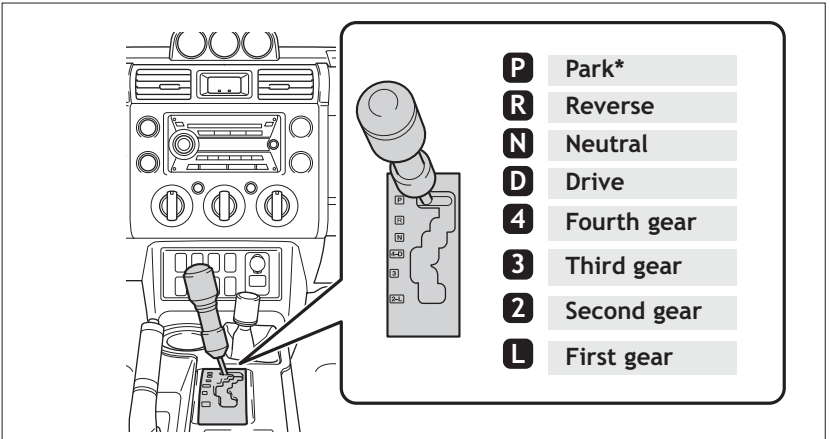

* The key must be in the "ON" position and the brake pedal depressed to shift from Park.

Downshifting increases power going uphill, or provides engine braking downhill. For best fuel economy during normal driving conditions, always drive with the shift lever in the "D" position.

Tilt steering wheel

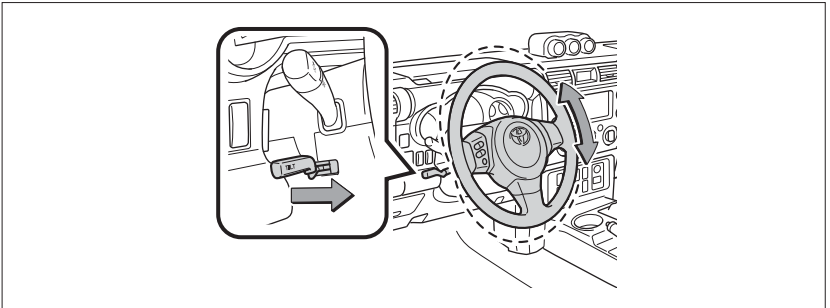

Hold the steering wheel, pull the lock release lever, tilt to the desired angle and release the lever.

NOTE: Do not attempt to adjust while the vehicle is in motion.

Four-wheel drive (if equipped)

Part-time four-wheel drive models

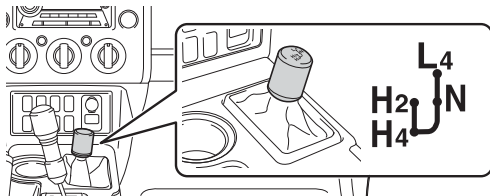

H2 High speed (2WD)

H4 High speed (4WD)
Shift to "H4" with speed below 50 mph.

L4 Low speed (4WD)
Stop vehicle, shift to "N" position, then move the lever to "L4."

NOTE: For best fuel economy and performance under normal driving conditions, shift vehicle into "H2" position.

Full-time four-wheel drive models

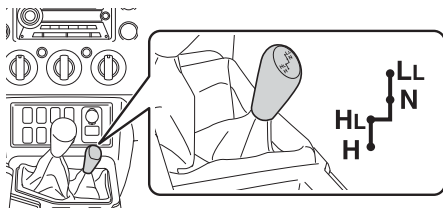

H High speed

HL High speed
Center differential locked. Depress the clutch pedal to shift from "LL."

LL Low speed
Center differential locked. Depress the clutch pedal to shift from "HL" when vehicle is stopped or when speed is below 5 mph.

NOTE: For best fuel economy and performance under normal driving conditions, shift vehicle into "H" position.

Rear differential lock button

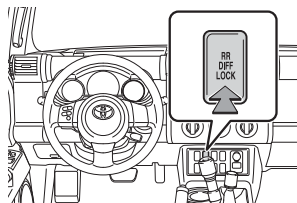

Before using the rear differential lock button:

- Shift the lever into "L4" (Automatic Transmission)
- Shift the lever into "LL" (Manual Transmission)

Rear differential lock/unlock

Parking brake

Set

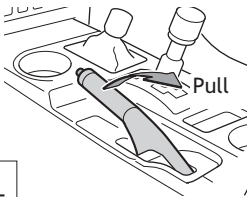

Release

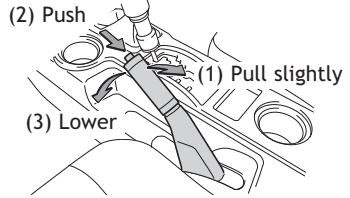

Seat adjustments-Front

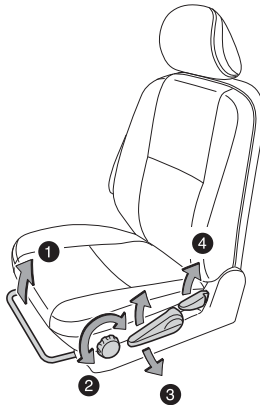

- ① Seat position (forward/backward)
- ② Cushion angle (driver side only)
- ③ Height crank (driver side only)
- ④ Seatback angle

Seats-Head restraints

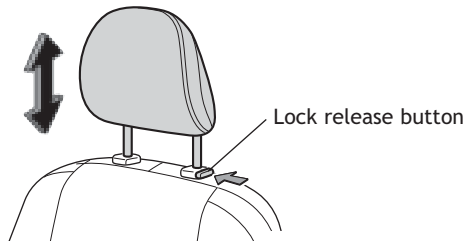

Seats-Folding rear seats

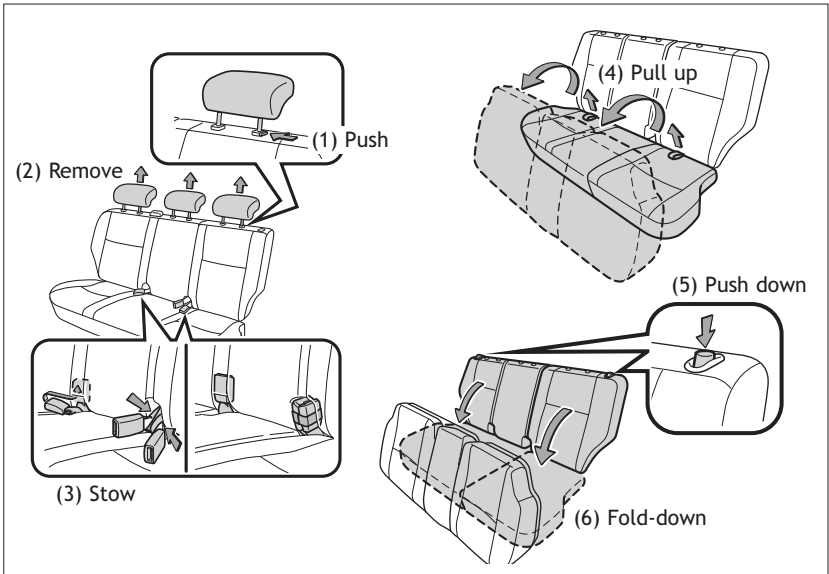

Seats-Removing rear seats

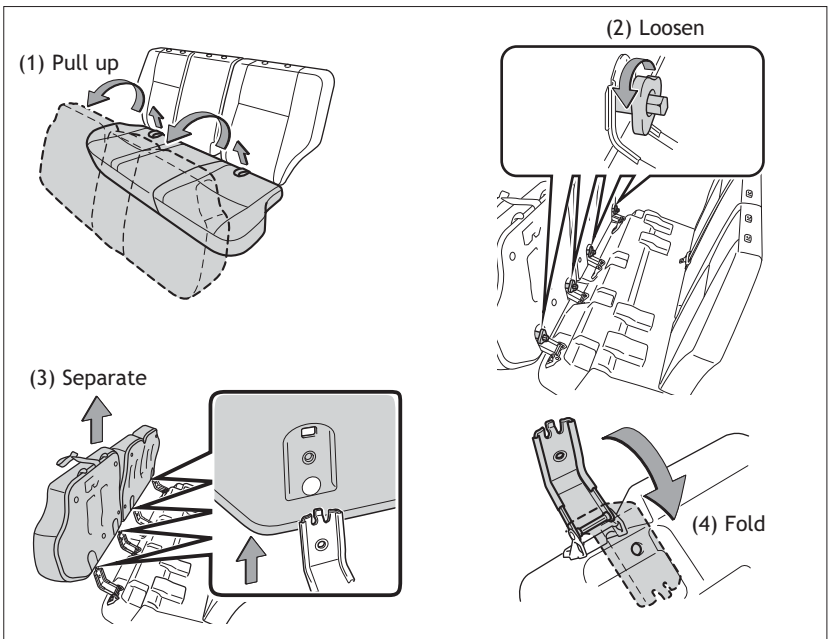

Lights & turn signals

Headlights

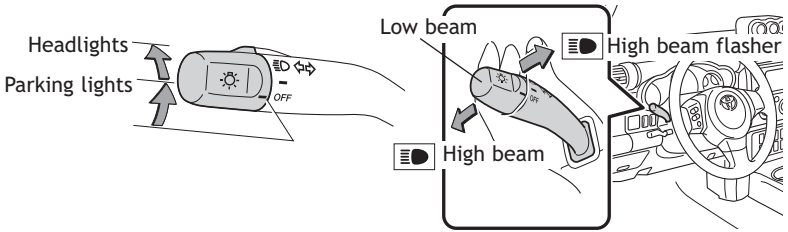

-Automatic light cutoff system Automatically turns lights off after 30 seconds when all doors are closed with the key in "ACC" or "LOCK." Lights may also be turned off by pushing lock button on remote after locking.

-Daytime Running Light system (DRL) (if equipped) Automatically turns on the headlights at a reduced intensity.

Turn signals

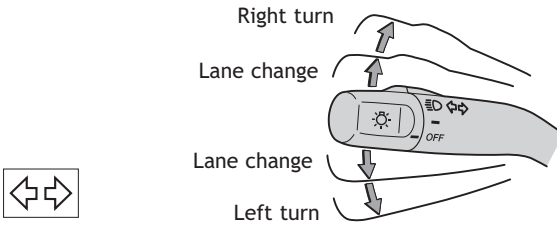

Windshield wipers & washers

Front

Adjust frequency*

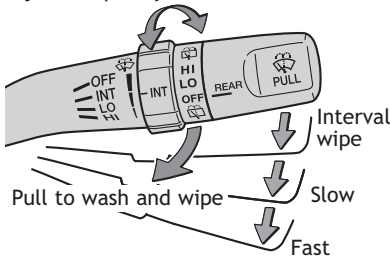

*** Intermittent windshield wiper frequency adjustment**
Rotate to increase/decrease wipe frequency.

Rear (if equipped)

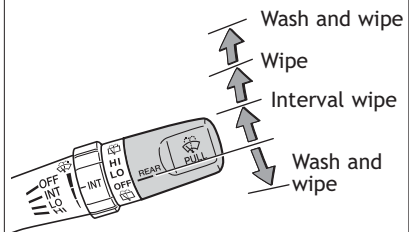

NOTE: Rear wiper and washer operate only when back window is fully closed.

Windows

Driver side

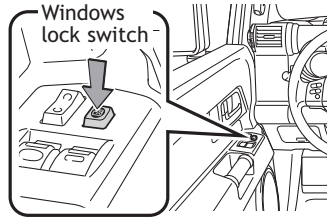
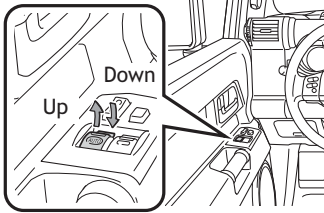

Automatic down operation (driver side only) Push the switch completely down and release to fully open. To stop window at any point, lightly pull the switch up.

Window lock switch Deactivates all passenger windows. Driver's window remains operable.

Door-Back

Open/Close

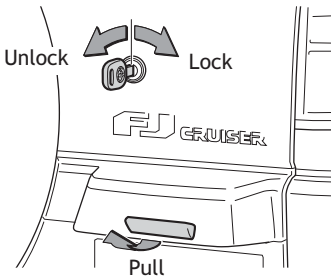

Lock in place

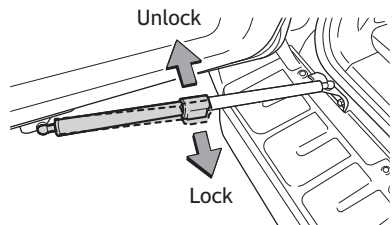

Back door can be locked into place when it is fully open.

Accessory meter (if equipped)

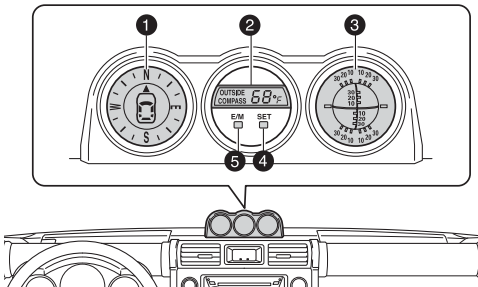

- ① Compass
- ② Outside temperature display
- ③ Clinometer-vehicle slant
- ④ Calibrating the compass setting
- ⑤ Switching between Fahrenheit and Celcius on thermometer

Audio

Type 1

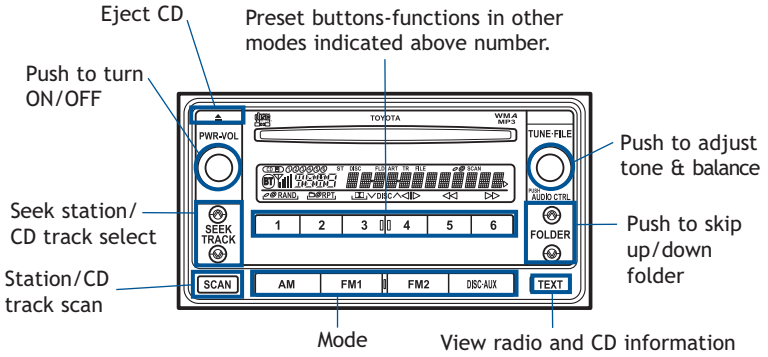

Type 2

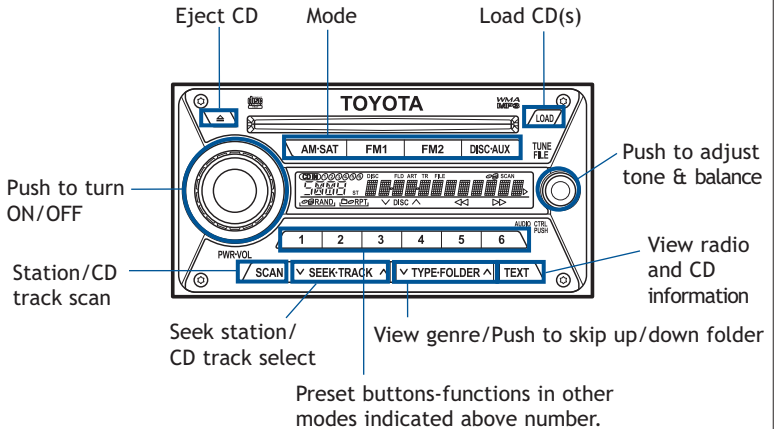

CD PLAYER

To scan tracks on a disc Push "SCAN." Push again to hold selection.

CD Changer (Type 2)

- To load one disc Push "LOAD" and insert one disc.
- To load multiple discs Push and hold "LOAD" until you hear a beep. Insert one disc. Shutter will close and then re-open for next disc.
- To select a file (MP3/WMA only) Turn "TUNE·FILE."
- To select a folder (MP3/WMA only) Push either side of "FOLDER" or "TYPE/FOLDER."

RADIO

Preset buttons Tune in the desired station and press a preset button (1-6) until you hear a beep. Push desired preset button (1-6) to select.

“SCAN” Push and hold “SCAN” to scan preset stations. Push again to hold selection.

Steering wheel switches (if equipped)

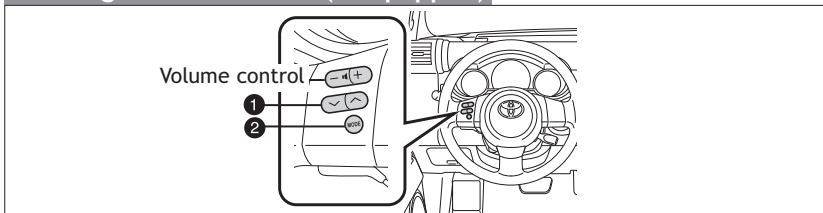

① **“V A”**

Use to search within the selected audio medium (radio, CD, iPod, etc.).

② **“MODE”**

Push to turn audio ON and select an audio mode. Push and hold to turn audio OFF.

Subwoofer switch (if equipped)

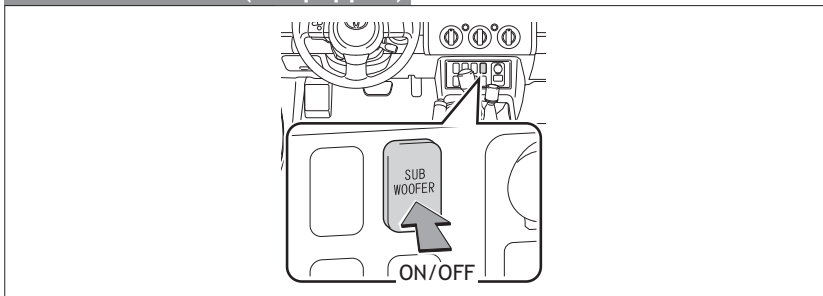

AUX audio jack

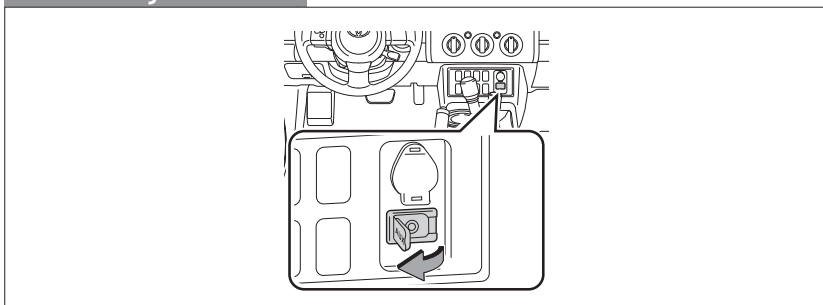

By inserting a mini plug into the AUX audio jack, you can listen to music from a portable audio device through the vehicle's speaker system while in AUX mode.

Air Conditioning/Heating

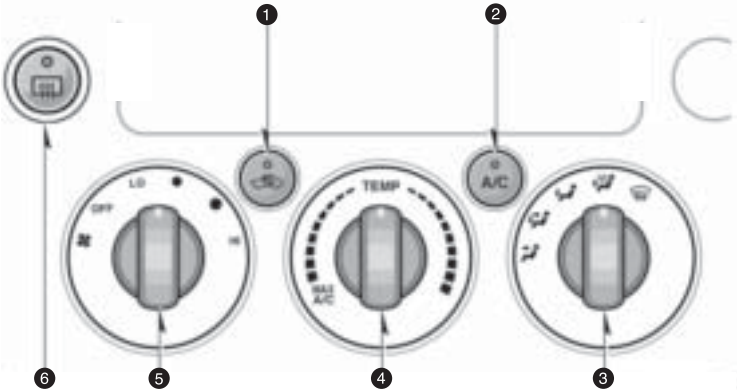

- ① Fresh or recirculated cabin air
- ② Air Conditioning ON/OFF
- ③ Airflow vent
In " " mode, use fresh air (" " indicator OFF) to reduce window fogging. " " mode uses fresh air only.
- ④ Temperature selector
- ⑤ Fan speed
- ⑥ Rear window defogger

Clock

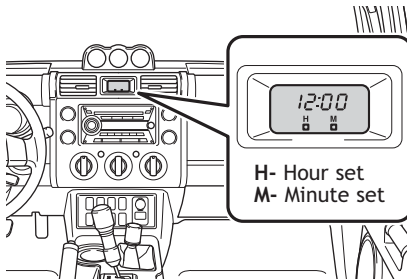

Cruise control (if equipped)

Turning system ON/OFF

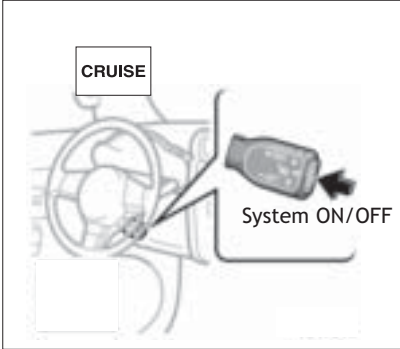

Functions

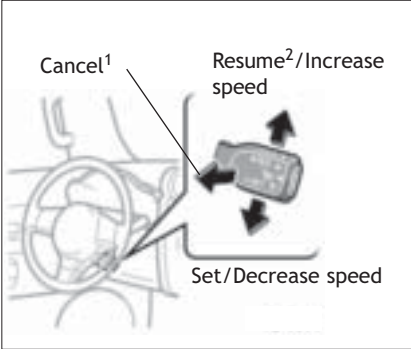

¹ The set speed may also be cancelled by depressing the brake pedal.

² The set speed may be resumed once vehicle speed exceeds 25 mph.

Intuitive parking assist (if equipped)

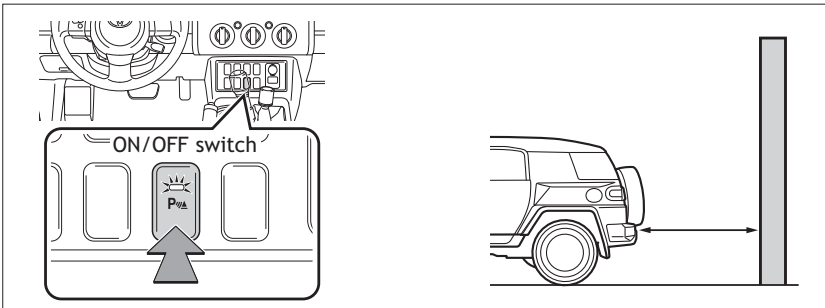

When vehicle is in reverse, a buzzer will sound to inform driver when nearing an obstacle. The system can only be used when the transmission is in the "R" position.

Light control-Instrument panel

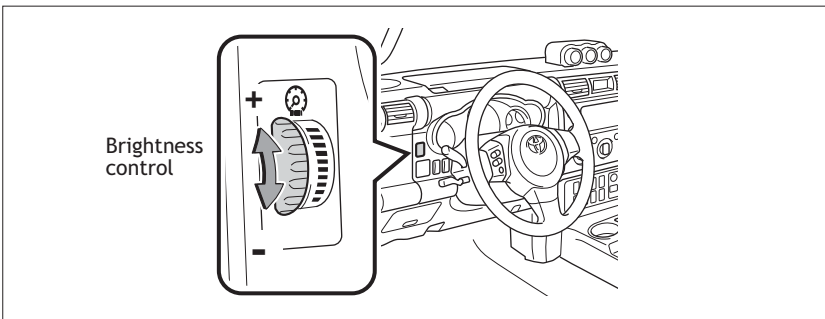

VSC OFF button

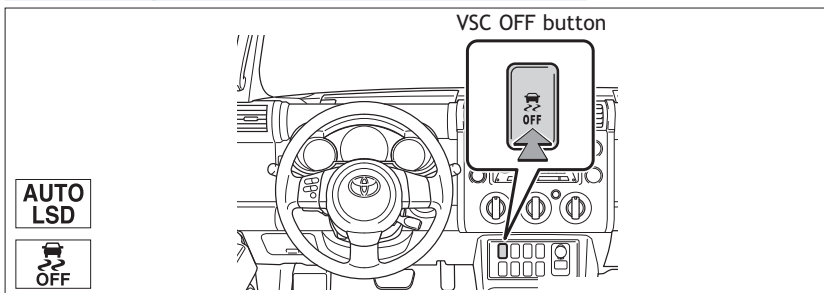

The VSC OFF button is used to switch between modes related to the TRAC, VSC and Auto LSD functions.

Refer to Section 2-4 of the *Owner's Manual* for more information.

Power outlet-12V DC

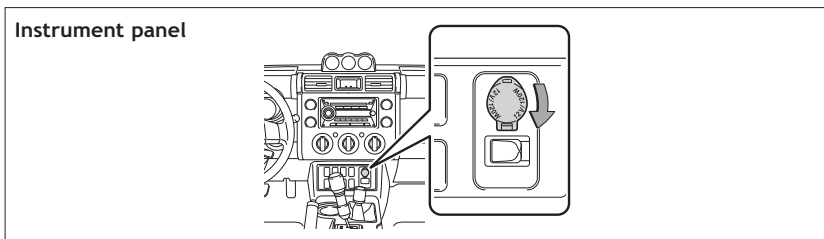

Key must be in the "ACC" or "ON" position to be used.

Power outlet-115V AC (if equipped)

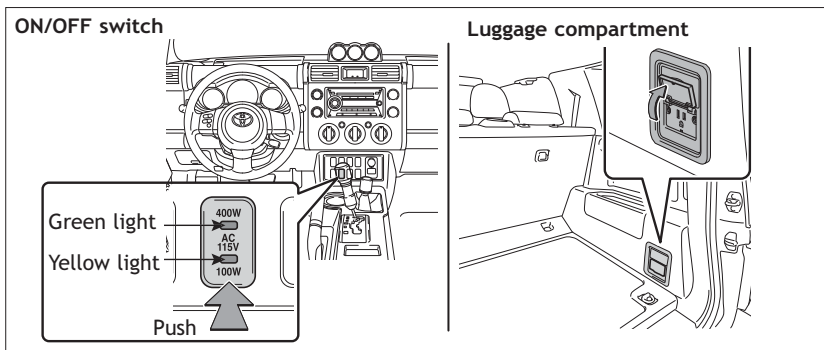

The illumination changes according to the maximum available capacity.

- Green and Yellow 115V AC/400W
- Yellow 115V AC/100W

Engine must be running in order to use the 115V AC power outlet.

Bottle holders-Rear seat

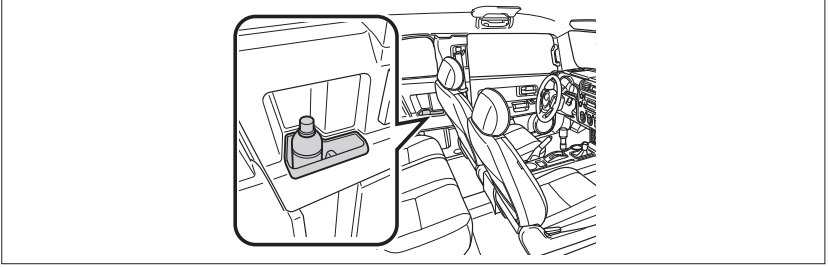

Cup holders

Automatic Transmission models

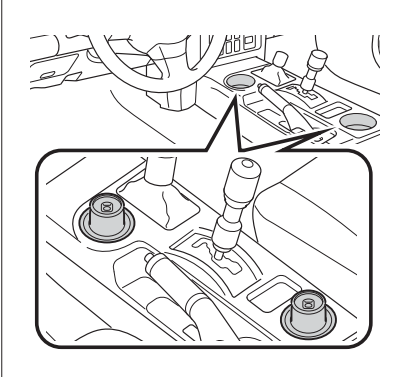

Manual Transmission models

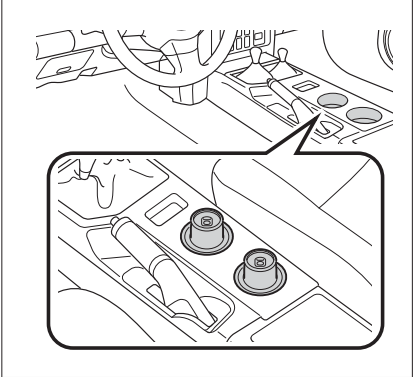

Rear console

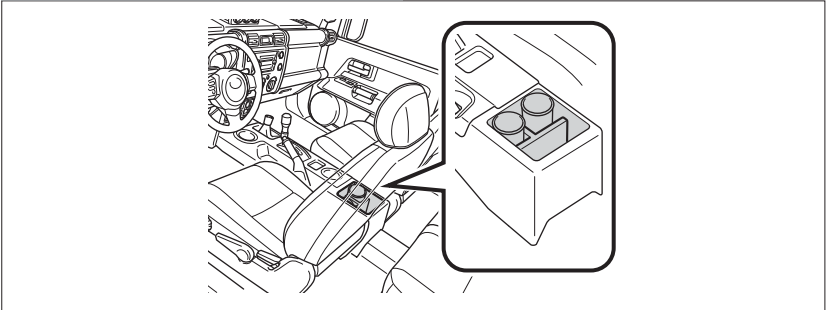

SAFETY AND EMERGENCY FEATURES

Seat belts

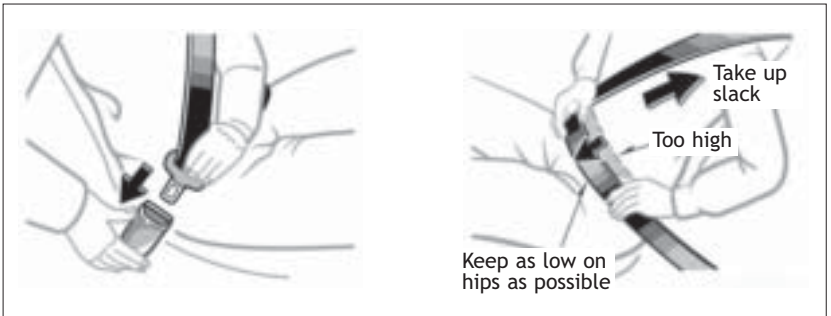

If belt is fully extended, then retracted even slightly, it cannot be re-extended beyond that point, unless fully retracted again. This feature is used to help hold child restraint systems securely.

To find more information about seat belts, and how to install a child restraint system, refer to the *Owner's Manual*.

Seat belts-Shoulder belt anchor

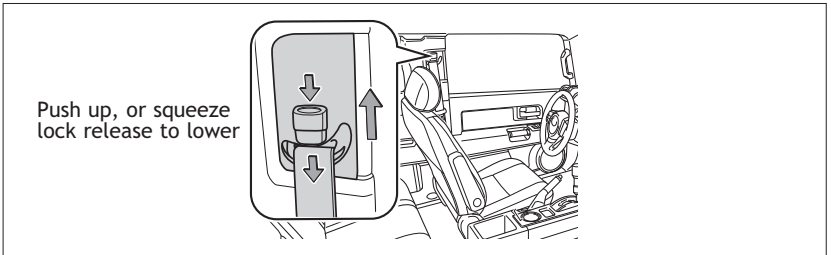

Door locks

